

ITEM NO	DESCRIPTION	QTY IN KIT
1	WASHER, FLAT 3/8" X 1.25" OD SS	3
2	BOLT, 3/8" X 1.5" HEX, SHOULDER	3
3	BOLT, CARRIAGE 5/16-18 TH	2
4	SQUARE WASHER	2
5	NUT, FLANGE 5/16-18 SST	2
6	FOOT, EXTRUDED L - SLOTTED	3

Part Number	Description
BX-MA-FRA-M1	BX FLAT ROOF MOUNTING ASSEMBLY

1) Washer Flat 3/8 x 1.25 OD SS

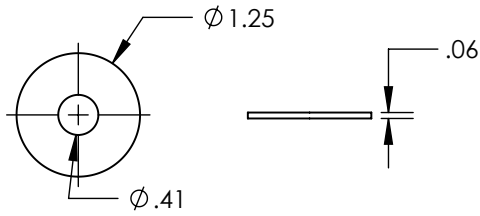

Property	Value
Material	300 Series Stainless Steel
Finish	Mill

2) Foot, Extruded L -Slotted

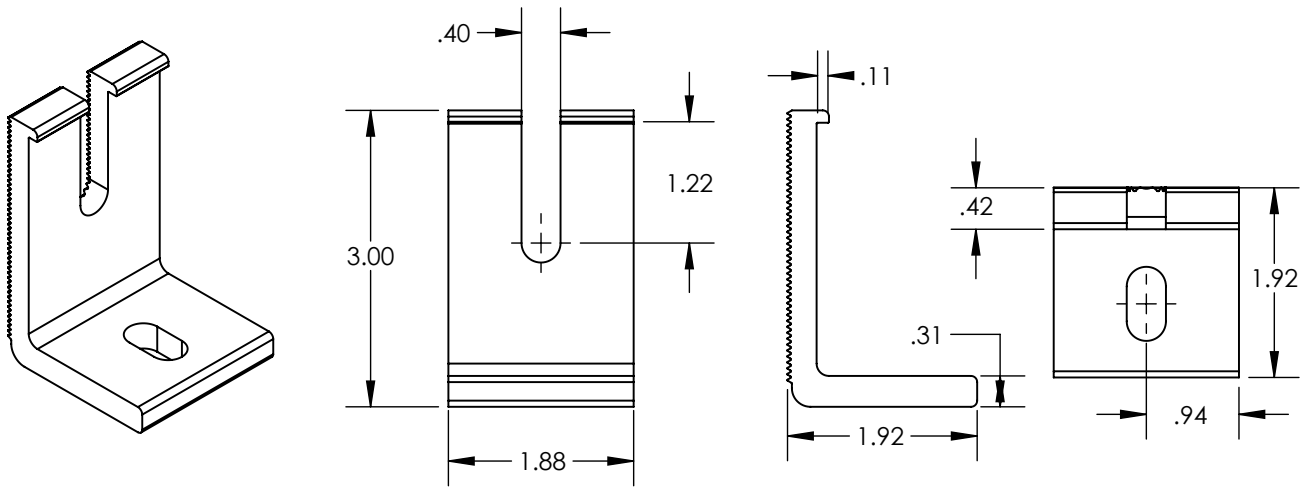

Property	Value
Material	6000 Series Alluminum
Finish	Mill

3) Carraige Bolt, 5/16-18 X 1.5

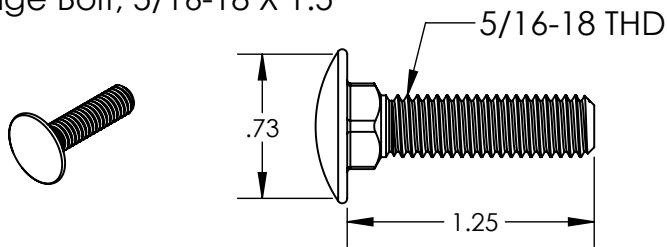

Property	Value
Material	300 Series Stainless Steel
Finish	Clear

4) Square Washer

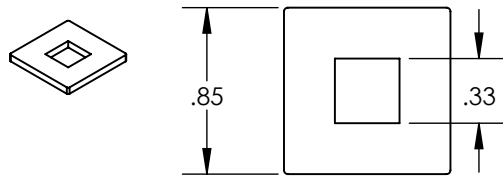

Property	Value
Material	300 Series Stainless Steel
Finish	Clear

5) Nut, Flange 5/16-18 SST

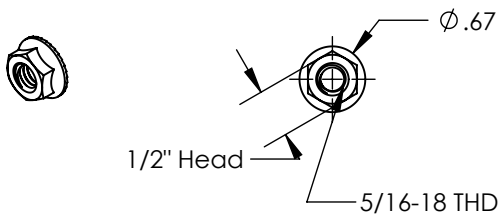

Property	Value
Material	300 Series Stainless Steel
Finish	Clear

6) Bolt, 3/8" X 1.5" HEX

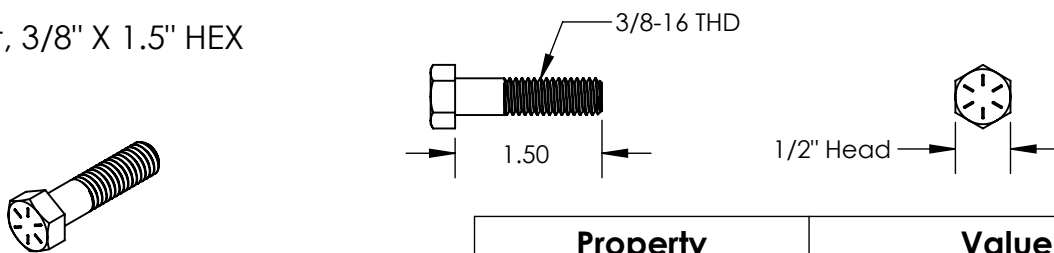

Property	Value
Material	300 Series Stainless Steel
Finish	Clear

Strut items not included in kit, shown for reference

Strut Channel

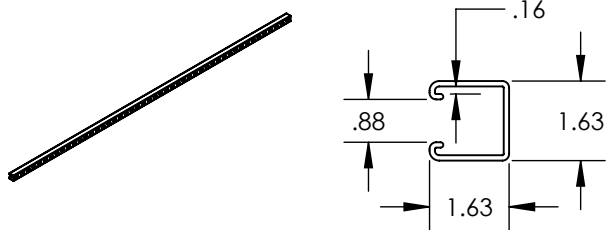

Channel Nut

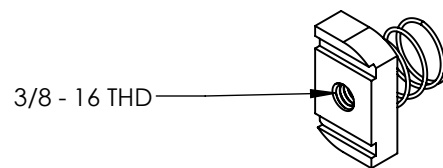

Property	Value
Material	Steel
Finish	Galvanized